

Reference Manual – English
Mu-so and Mu-so Qb



Contents

Section	Page	Section	Page
Introduction	1	Diagram 16	
1. Getting Started	1	TIDAL stream playing	15
1.1 Installation	2	Diagram 17	
Diagram 1 – Mu-so		iRadio input	15
Mu-so underside connections	3	Diagram 18	
Diagram 2 – Mu-so		Local inputs	15
Mu-so side panel features	3	5.2 The Mu-so Remote Control Handset	16
Diagram 3 – Mu-so Qb		Diagram 19	
Mu-so Qb connection panel	4	Mu-so remote handset	16
1.2 Switch On and Standby	4	5.3 The Naim App	17
		Diagram 20	
2. Network Connection	5	Naim App Setup	17
2.1 Wireless Network Connection	5	Diagram 21	
Diagram 4		Naim App Home	17
Naim App Welcome screen	5	Diagram 22	
Diagram 5		Naim App	
Wireless Accessory Configuration	6	Settings	18
Diagram 6		6. Installation Notes	19
Wi-Fi key sharing	6	6.1 Handling Mu-so	19
Diagram 7		6.2 Cleaning Mu-so	19
Setup web page - Overview	7	6.3 Grille Replacement	19
Diagram 8		6.4 Firmware Update	19
Setup web page - Network	8	6.5 Lightning Precautions	19
2.2 Wired Network Connection	8	6.6 Defaults	19
		6.7 Problems?	19
3. Bluetooth Connection	9	6.8 Service and Contact	19
Diagram 9			
Bluetooth setup	9	7. Specifications	20
4. Music Sources	10		
4.1 Local Sources	10	8. Acknowledgements	21
4.2 iRadio	10		
4.3 Audio Streams	10		
5. Control	12		
5.1 The Touch Panel and Rotary Control	12		
Diagram 10			
Touch Panel and Rotary Control	13		
Diagram 11			
Touch Standby to switch on and off			
Turn the rotary control to adjust volume	13		
Diagram 12			
Bluetooth stream playing	13		
Diagram 13			
UPnP™ stream playing	14		
Diagram 14			
AirPlay stream playing	14		
Diagram 15			
Spotify® Connect stream playing	14		

Introduction

Welcome to Mu-so® and congratulations on your purchase. Mu-so and Mu-so Qb bring renowned Naim Audio performance to compact, all-in-one music players for the first time and combine exceptional performance with a comprehensive collection of audio inputs and sources. With Mu-so and Mu-so Qb you can:

- Listen to thousands of internet radio stations.
- Play audio using AirPlay®.
- Play audio using Spotify® Connect (a Spotify® Premium subscription is required) and TIDAL (a TIDAL subscription is required).
- Play audio wirelessly using Bluetooth® with AAC and aptX® encoding from any compatible playback device.
- Play audio from UPnP™ music servers.
- Play audio from, or stream audio to, other Naim streaming products.
- Play audio stored on your iPod®, iPhone®, iPad® and other USB memory devices via a USB connection.
- Play analogue or digital audio using a wired connection from any playback device with a suitable audio output socket.

1. Getting Started

This manual provides comprehensive information on all Mu-so and Mu-so Qb features and facilities and will enable you to setup your Mu-so or Mu-so Qb perfectly to integrate with your existing home entertainment systems and media.

If you wish to play some music immediately, the Quick Start Guide found within its document pack will guide you quickly through the process of network and Bluetooth connection.

If you have questions not answered within these pages help can be found at: www.naimaudio.com/mu-so-support, by email at mu-sosupport@naimaudio.com, or by calling:
+44 (0)333 321 9923 (UK)
+1 800 961 5681 (USA and Canada).

Mu-so and Mu-so Qb can be controlled from their combined touch panel and rotary control or the free Naim iOS or Android app. Mu-so is also supplied with a remote control handset that provides a basic set of control functions. The handset can be purchased as an accessory to work with Mu-so Qb.

The Naim App offers the most comprehensive set of control and setup facilities and we strongly recommend that before you begin to use your Mu-so or Mu-so Qb you download and install the app on your iOS or Android device. The Naim App can be found easily in both the iTunes App Store and Google Play Store.

Note: The Naim App requires iOS version 7.1 or later, or Android version 4.0 or later.

1. Getting Started

1.1 Installation

Mu-so and Mu-so Qb are designed to be located either on a table, a furniture unit or a wall shelf. If a shelf is to be used be sure that it is able to support the weight.

Important: Items of any weight placed on the Mu-so or Mu-so Qb top surface may damage its finish.

Important: Never place any item containing liquid, such as a vase, a cup or a glass, on the Mu-so or Mu-so Qb top surface.

1.1.1 Mu-so Connections

A connection panel located on the Mu-so underside incorporates a mains input socket, a wired network socket, and a TosLink optical digital audio socket intended for the connection of external digital audio sources; a CD player for example. The underside connection panel is illustrated in Diagram 1.

Important: Take great care when lifting and carrying Mu-so, and when accessing the underside connection sockets. Do not stand Mu-so on its front grille or either end panel, or invert it fully to stand on its top panel. Mu-so can be stood temporarily on its rear heatsink in order to gain access to the underside connection sockets. Ensure however that the heatsink is protected from damage.

If your Mu-so is to use a wired network connection begin by connecting a standard Ethernet cable to the network socket. Otherwise, first connect Mu-so to a suitable mains supply using the supplied mains cable.

Note: Mu-so is supplied with a mains cable appropriate for the territories in which it is sold.

1.1.2 Mu-so Side Panel Features

The Mu-so right-hand side panel, illustrated in Diagram 2, also incorporates some connection and installation facilities. These include:

- A Wi-Fi set up and factory defaults pin-hole button. See Section 2.1 for more on Wi-Fi set up, and see Section 6.6 for more on returning a Mu-so to its default settings.

- A multicolour status indicator. See Section 2 for information on indicator colours.
- A 3.5mm jack analogue audio socket for the connection of external analogue audio sources.

Note: Mu-so will automatically select its analogue input when a plug is inserted in the socket.

- A USB socket for the connection of USB memory hardware and iOS audio playback devices.

1.1.3 Mu-so Qb Connections and Installation Features

Mu-so Qb connection and installation facilities can be found on its rear panel. These include:

- A mains input socket.

Note: Mu-so Qb is supplied with a mains cable appropriate for the territories in which it is sold.

- A USB socket for the connection of USB memory hardware and iOS audio playback devices.
- A wired network socket.
- A TosLink optical digital audio socket intended for the connection of external digital audio sources.
- A 3.5mm jack analogue audio socket for the connection of external analogue audio sources.
- A Wi-Fi set up and factory defaults pin-hole button. See section 2.1 for more on Wi-Fi set up, and Section 6.6 for more on returning Mu-so Qb to its default settings.
- A multicolour status indicator. See Section 2 for information on indicator colours.

The Mu-so Qb connection panel is illustrated in Diagram 3.

1. Getting Started

Diagram 1 – Mu-so
Mu-so underside connections

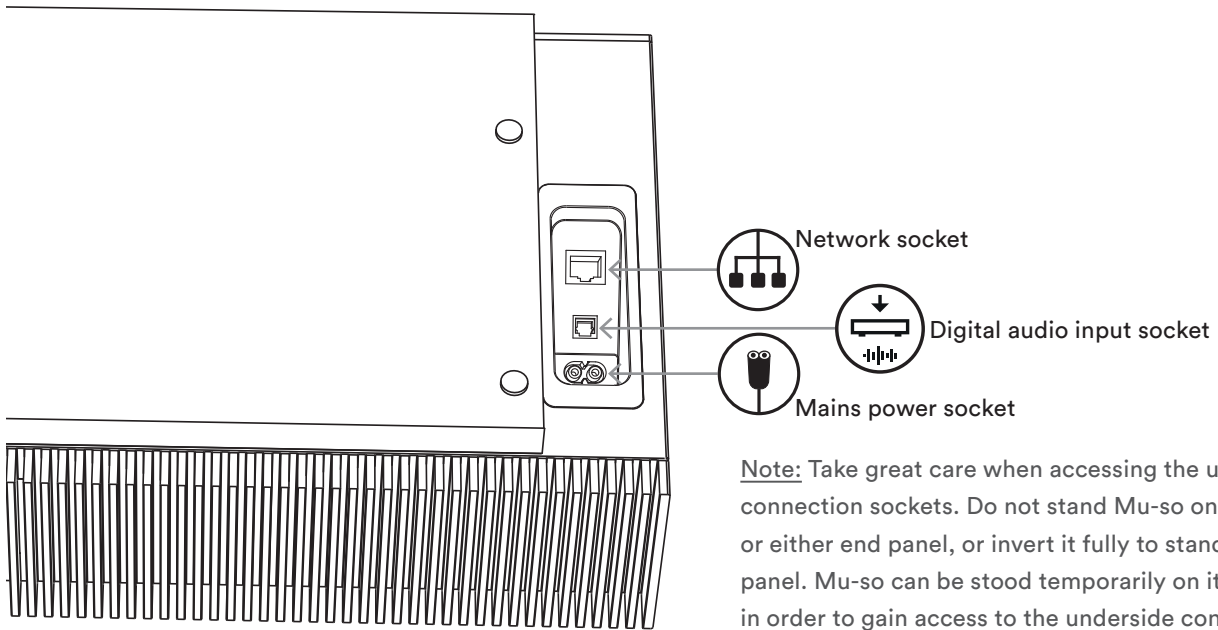

Note: Take great care when accessing the underside connection sockets. Do not stand Mu-so on its front grille or either end panel, or invert it fully to stand on its top panel. Mu-so can be stood temporarily on its rear heatsink in order to gain access to the underside connection sockets. Ensure however that the heatsink is protected from damage.

Diagram 2 – Mu-so
Mu-so side panel features

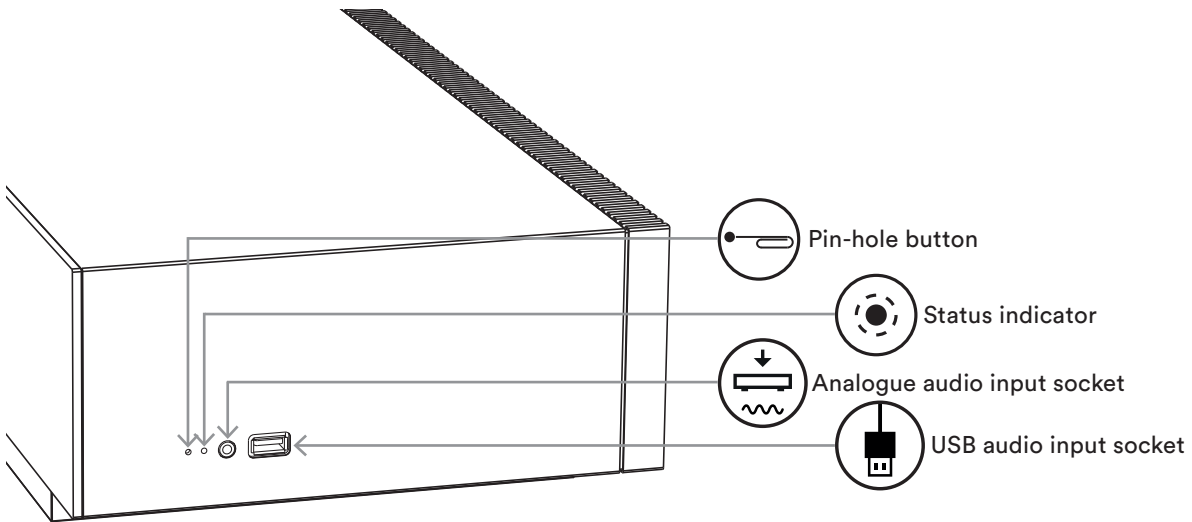

1. Getting Started

Diagram 3 – Mu-so Qb
Mu-so Qb connection panel

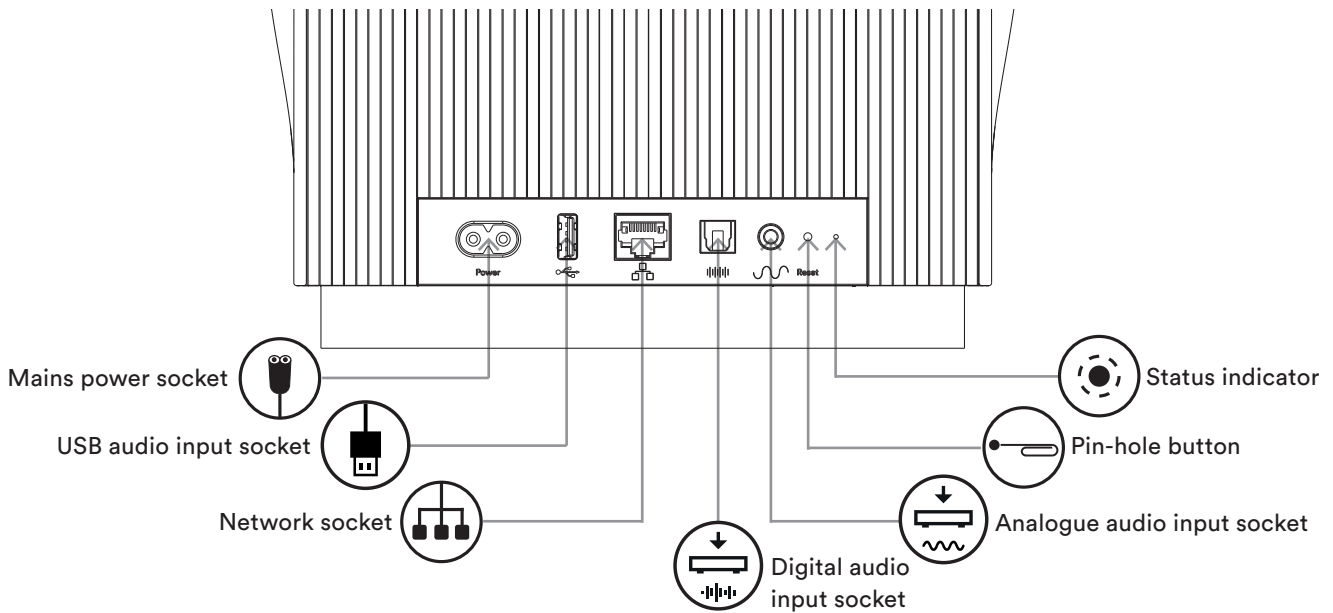

1.2 Switch On and Standby

Mu-so and Mu-so Qb will immediately switch-on when connected to a mains supply.

There are two standby modes: standby and deep sleep. In standby mode network and Bluetooth connections remain operational to enable Mu-so and Mu-so Qb to “wake” automatically when in receipt of a Naim App control command or a music stream. In deep sleep mode network and Bluetooth functions will shut-down in order to reduce power consumption to a minimum.

- To switch Mu-so or Mu-so Qb into standby mode tap the touch panel Standby icon. Tap the Standby icon to leave standby mode.

- To switch Mu-so or Mu-so Qb into deep sleep mode touch and hold the touch panel Standby icon, or press and hold the Mu-so handset Standby button. The display segment above the Standby icon will flash as deep sleep mode is engaged. Touch the Standby icon or handset button again to wake from deep sleep.

Note: If unused for 20 minutes Mu-so and Mu-so Qb automatically enter standby mode. The auto standby time can be adjusted via the Naim App Settings menus.

2. Network Connection

In order to play streamed audio files and internet radio stations Mu-so and Mu-so Qb must be connected to the internet via a local network router. Connection to the router may be wired or wireless.

The following Section 2 paragraphs are equally applicable to both Mu-so and Mu-so Qb and describe the procedures for wireless and wired connection.

Note: Mu-so is configured by default to communicate with home networks automatically using the standard DHCP protocol. Mu-so can be configured to use a fixed IP address via its internal web setup pages. See Section 2.2 for more information.

Note: If your Mu-so has been previously used it is good practice to return it to its default settings before attempting to connect it to your network. The factory default procedure will erase any existing user and network settings and restore the default iRadio presets. See Section 6.6 for more information.

The status indicator adjacent to the pin-hole button illuminates to indicate different network and functional states. The illumination is listed in the following table:

Illumination		Network and Functional State
Off		Deep sleep/off
White	○	Network connected
Orange	●	No network
Orange (flashing)	⊙	Network connection starting
Purple	●	Wireless connection configured but network not found
Purple (flashing)	⊙	Wireless setup mode
Blue	●	Firmware update underway or unit in recovery mode
Red (flashing)	⊙	System fault or amplifier overload (contact your retailer or Mu-so support)

2.1 Wireless Network Connection

In order for Mu-so to connect to the internet via a local wireless network it must be configured with the wireless network name (SSID) and password (security key). There are three different methods achieving this. The method you choose will depend on personal preference and convenience.

Note: Mu-so is compatible with the 802.11b and 802.11g Wi-Fi standards.

Note: Mu-so cannot connect to a “hidden” wireless network.

2.1.1: Wireless Setup Using the Naim App

The Naim App incorporates a wireless setup routine that will guide you through the process of connecting Mu-so wirelessly to your local network. If you have not already downloaded and installed the Naim App you should do so now. Follow the steps below to implement the Naim App wireless setup routine.

- Ensure that the iOS or Android device on which you have installed the Naim App is connected to the same wireless network you wish your Mu-so to use.
- Open the Naim App and select Setup new Mu-so.
- Follow the on-screen instructions to connect Mu-so to the wireless network. Diagram 4 illustrates the Naim App setup page.

Diagram 4
Naim App Welcome screen

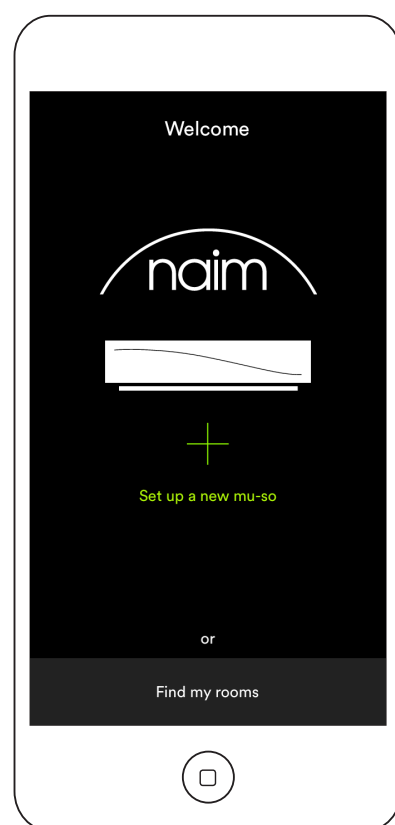

2. Network Connection

2.1.2: Wi-Fi Setup Using iOS Wireless Accessory Configuration

Mu-so can take advantage of the Wireless Accessory Configuration feature incorporated in iOS version 7 or later. Wireless Accessory Configuration enables a wireless capable product such as Mu-so to be configured automatically to join the same wireless network as the iOS mobile device. To use Wireless Accessory Configuration follow the steps below:

- Ensure that the wireless network that your iOS device is connected to is the one you wish your Mu-so to use.
- Ensure Mu-so is connected to a mains power supply and not in standby mode. Ensure no network cable is connected.
- Using the pin-tool supplied or a straightened paperclip, briefly press the pin-hole button to engage wireless set up mode. The status indicator will flash purple.

Note: If your Mu-so is previously unused it may start up in wireless set up mode with the indicator flashing purple.

- Open the wi-fi settings menu of the iOS device and scroll down the display. Select the SET UP NEW AIRPLAY SPEAKER item and follow the steps described. Diagram 5 illustrates the wi-fi settings menu.
- The Wireless Accessory Configuration procedure will now automatically send the network name and security key that the iOS device is using to your Mu-so and set up its wi-fi configuration.
- The Mu-so status indicator will stop flashing and illuminate white when the wireless connection has been successfully established.

Diagram 5
Wireless Accessory Configuration

Note: Wireless Accessory Configuration is only available with iOS Version 7 or later.

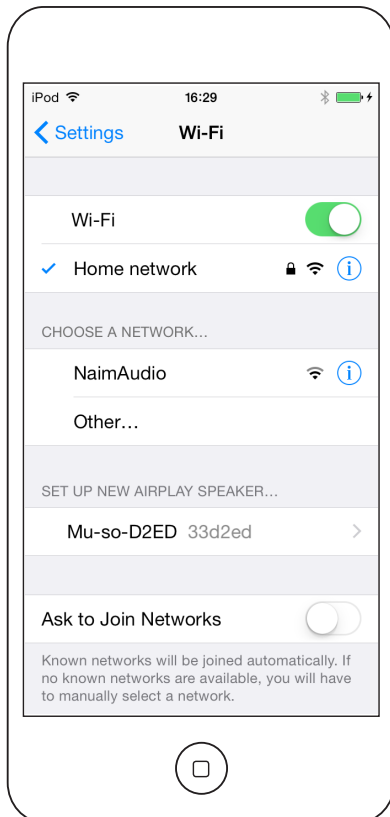

2.1.3: Wireless Setup Using iOS Wi-Fi Key Sharing

Mu-so can take advantage of the Wi-Fi Key Sharing feature incorporated in iOS version 6 or later. Wi-Fi Key Sharing enables a wireless capable product such as Mu-so to connect via USB to an iOS device and automatically copy the network name and security key that the device is using. To use Wi-Fi Key Sharing follow the steps below:

- Ensure that the wireless network that your iOS device is connected to is the one you wish your Mu-so to use.
- Ensure Mu-so is connected to a mains power supply and not in standby mode. Ensure no network cable is connected.
- Connect the iOS device to the Mu-so USB socket. The iOS device must be switched on and unlocked.
- Using the pin-tool supplied or a straightened paperclip briefly press the pin-hole button. The status indicator will flash purple.
- A dialogue window will display on the iOS device screen requesting permission to share Wi-Fi settings. Select "Allow". Diagram 6 illustrates the dialogue window
- After approximately 30 seconds Mu-so will be available for wireless streaming on your home network. The Mu-so status indicator will illuminate white.

Diagram 6
Wi-Fi key sharing

Note: Wi-Fi Key Sharing is only available with iOS Version 6 or later.

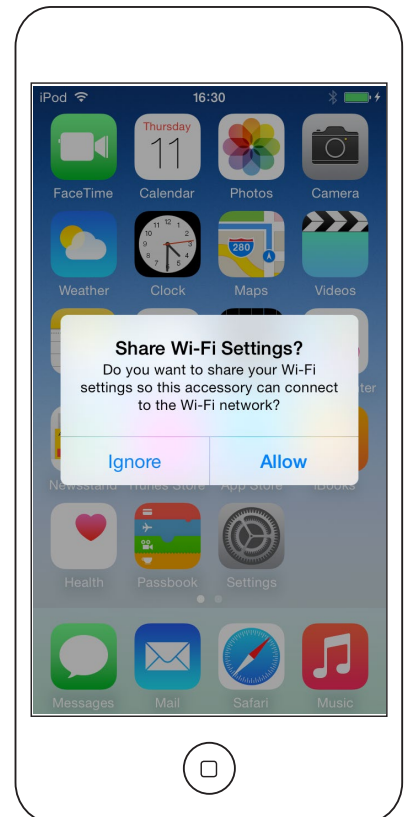

2. Network Connection

2.1.4: Wireless Setup Using a Wireless Connection

When not connected to a local wireless network, Mu-so can broadcast its own wireless signal that can be used to access its internal web setup page. The name and password of the wireless network you wish Mu-so to connect to can be specified on the setup page. To access the Mu-so setup page wirelessly follow the steps below.

- Using the pin-tool supplied, or a straightened paper clip, briefly press the pin-hole button. The status indicator will change colour and flash.

Note: The Mu-so wireless network broadcast will switch off automatically after 30 minutes. It can be re-started by pressing the pin-hole button again.

Open the computer, laptop, tablet or smart phone wireless setup page or control panel and look for a local wireless network called 'Mu-so-XXXX-Setup'. This is a wireless network generated by Mu-so itself that enables temporary connection for setup purposes.

Note: The default Mu-so network and Bluetooth name incorporates the last four characters of the unique MAC address printed on a label on the underside of each unit.

Select the Mu-so wireless network and connect to it. No password will be required.

Note: Windows may require confirmation of network type. Select "Home".

- Close the computer, laptop, tablet or smart phone wireless setup page or control panel.
- Open a web browser window on the computer, laptop, tablet or smart phone and type 192.168.1.12 in the address bar. Press return or select "Go".
- The browser will display the Mu-so Setup page. In the 'Network' tab, select the wireless network you wish Mu-so to use and enter the password in the appropriate dialogue box. Select Enter. Diagram 7 illustrates the Mu-so Setup page home screen.
- Close the browser window.
- Return to the computer, laptop, tablet or smart phone wireless setup page or control panel and re-connect to your local network.
- After a few moments your Mu-so should be available for wireless streaming on your home network. The Mu-so status indicator will illuminate white.

Diagram 7
Setup web page - Overview

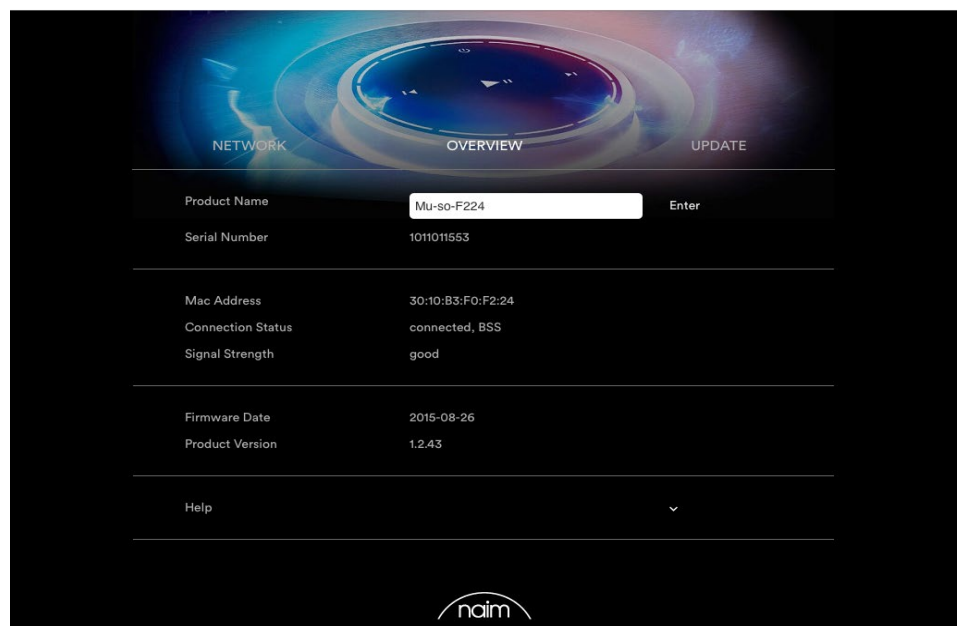

2. Network Connection

2.2 Wired Network Connection

To connect Mu-so to a local network using a wired connection follow the steps below:

- Disconnect Mu-so from mains power.
- Connect Mu-so to your local network router using a standard Ethernet cable.

After a few moments Mu-so should be available for streaming on your home network. The Mu-so status indicator will illuminate white.

Note: Mu-so can be configured to use a static IP address if required via the Advanced Settings tab on its setup page. Diagram 8 illustrates the setup page.

Diagram 8
Setup web page - Network

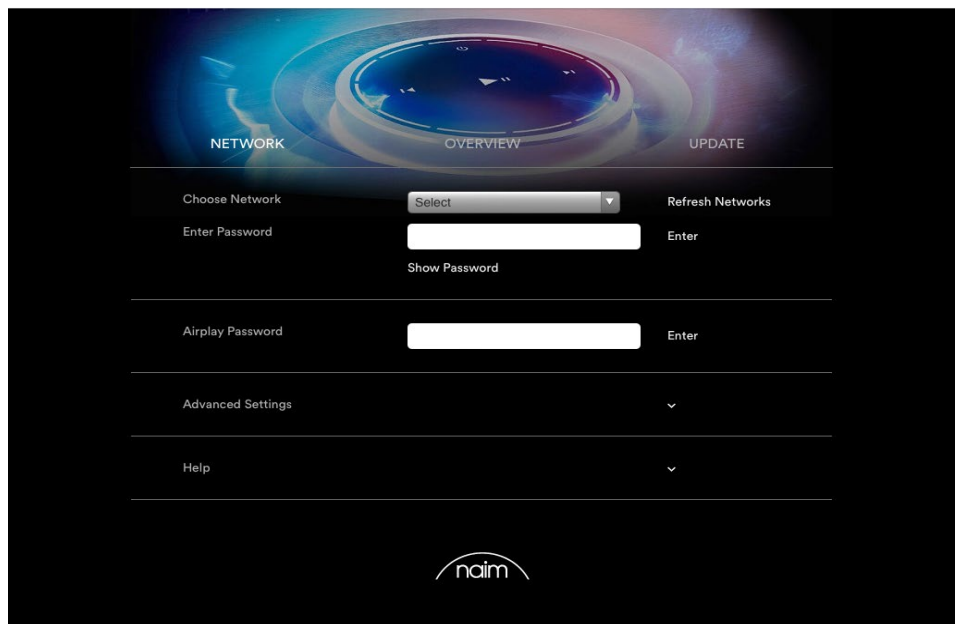

3. Bluetooth Connection

In addition to playing streamed audio via a local network, Mu-so and Mu-so Qb can play audio over a Bluetooth wireless connection from appropriately equipped playback devices.

The following Section 3 paragraphs are equally applicable to both Mu-so and Mu-so Qb.

Mu-so is configured by default with an “open” Bluetooth connection so does not require “pairing” with a specific playback device. To connect to a Bluetooth playback device open the playback device Bluetooth setup page and select Mu-so BT XXXX or Mu-so Qb BT XXXX in the list of available devices. After a short delay Mu-so will be available to the audio apps on the device for playback selection.

Note: Bluetooth wireless connections have a relatively limited range. A maximum of around 10 metres is typical in domestic environments, however physical obstructions in the transmission path may result in reduced range.

Note: The default Mu-so network and Bluetooth name incorporates the last four characters of the unique MAC address printed on a label on the underside of each unit adjacent to the mains input socket.

Bluetooth connection can be switched to a secure format via the Settings menu of the Naim App. A secure Bluetooth connection means that connected devices need to be specifically “paired” in order to stream audio. To switch to secure Bluetooth connection follow the steps below:

- Open the Naim App settings menu and select Input Settings > Bluetooth Security. Select Bluetooth Security “on”.
- Touch and hold the Mu-so touch panel input icon until the Bluetooth icon begins to blink.
- Open your Bluetooth playback device Bluetooth settings page and select “Mu-so-XXXX”.

Your Mu-so and playback device will now be securely paired. No other Bluetooth device will be able to connect to Mu-so unless it is similarly paired.

Note: If multiple devices are paired, Mu-so will play from the first device from which it receives a stream. If you wish to stream from a different paired device, the first device must be disconnected.

Note: Up to eight Bluetooth devices can be paired with

Mu-so simultaneously. If a ninth device is paired the oldest paired device will be deleted.

Note: Mu-so can be forced to disconnect and delete a paired Bluetooth device via the Naim App settings menus.

Diagram 9 illustrates Mu-so Bluetooth setup on an Android mobile device. Bluetooth setup on an iOS device is similar.

Diagram 9
Bluetooth setup

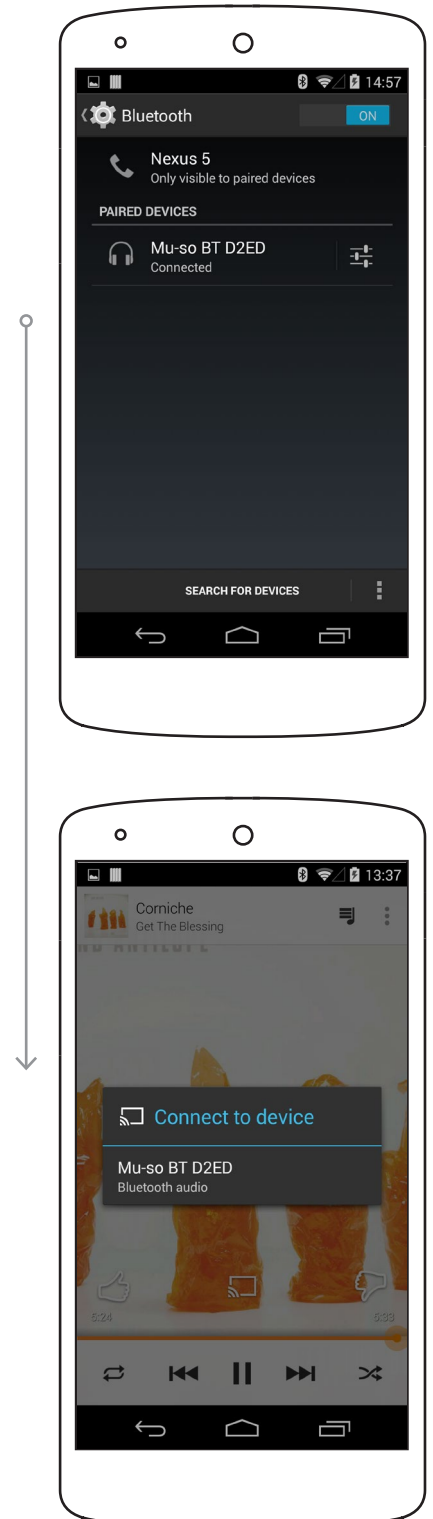

4. Music Sources

Mu-so and Mu-so Qb can play audio from a wide variety of sources, however the way they behave with each one varies. The following paragraphs describe different types of source and the manner in which Mu-so and Mu-so Qb handle them.

The following Section 4 paragraphs are equally applicable to both Mu-so and Mu-so Qb.

4.1 Local Sources

Local sources are those for which source devices are connected directly to a Mu-so input socket. They comprise the analogue and digital audio inputs and the USB audio input.

Local sources can be selected from the Mu-so touch panel interface or using the Naim App. The analogue source input is automatically selected when a plug is inserted in the Mu-so analogue input socket.

Note: The Mu-so digital audio input is a TosLink socket compatible with S/PDIF digital audio signals. Many CD players incorporate an appropriate digital audio output.

The behaviour of USB devices connected to Mu-so, and access to audio files they hold, varies depending on their type.

Audio files stored on USB memory devices can be browsed and selected for playback only by using the Naim App. Once playback is underway however the Mu-so touch panel and handset can also be used to select play/pause, next or previous.

Audio files stored on iOS devices can be played through the Mu-so USB input either under the local control of the iOS device or using the Naim App. In some cases, once playback is underway, the Mu-so touch panel can also be used to select play/pause, next or previous.

Note: Most UMS (Universal Mass Storage) USB devices are compatible with the Mu-so USB input. Mobile devices using the Android operating system are not compatible with the Mu-so USB input.

Mu-so can play audio files stored on USB memory hardware and playback devices in the following formats: MP3, ALAC, AAC, FLAC, WMA, WAV, AIFF or Ogg Vorbis.

4.2 iRadio

iRadio preset stations can be selected from the Naim App or from the Mu-so touch panel by repeated touches of the radio icon. However, iRadio station browse, search and preset store functions are only available using the Naim App.

Up to 40 preset iRadio stations can be stored using the Naim App, the first five of which are automatically made available for selection from the Mu-so touch panel. The identity of first five can be altered using the Naim App.

4.3 Audio Streams

Mu-so streaming sources comprise AirPlay, Bluetooth, Spotify® Connect, TIDAL, UPnP™ and Multiroom.

4.3.1 AirPlay and Bluetooth streams

AirPlay and Bluetooth cannot be selected from the Mu-so touch panel or the Naim App but are selected automatically when Mu-so receives a stream initiated from an appropriate playback app. The AirPlay or Bluetooth icons will illuminate on the Mu-so touch panel to indicate selection.

To play an AirPlay or Bluetooth stream, open the appropriate playback app on the streaming device (a Windows or OS X computer or an iOS or Android tablet or phone) and select Mu-so as the playback device.

Note: More information on Airplay and Bluetooth can be found at:

www.apple.com/airplay
www.bluetooth.com

4.3.2 Spotify® Connect streams

Spotify® Connect can be selected from the Naim App but will also select and play automatically when Mu-so receives a Spotify® Connect stream initiated from the Spotify® app. The Spotify® Connect icon will illuminate on the Mu-so touch panel to indicate selection.

To play a Spotify® Connect stream, open the Spotify® application on the streaming device (your Windows or OS X computer or your iOS or Android tablet or phone) and select Mu-so for playback.

Note: More information on Spotify® Connect can be found at: www.spotify.com/connect

4.3.3 TIDAL streams

TIDAL is available as a Mu-so input on the Naim App however there is no TIDAL icon on the Mu-so touch panel. To play a TIDAL stream, select the TIDAL input on the Naim App, sign-in to your TIDAL account and select music to play.

Note: More information on TIDAL can be found at: www.tidal.com

4. Music Sources

4.3.4 UPnP™ streams

The Mu-so UPnP™ input enables Mu-so to play audio files stored on UPnP™ servers such as the Naim UnitiServe, network servers with integrated UPnP™ software, or on Windows and OS X computers. The Mu-so UPnP™ input is selected automatically when in receipt of a stream from a server. UPnP™ file browsing can be carried out using the Naim App. Once playback has been initiated by a play command on the Naim App, the Mu-so touch panel, play/pause, next and previous controls can also be used to control playback.

Mu-so can play UPnP™ streamed audio files in the following formats: MP3, ALAC, AAC, FLAC, WMA, WAV, AIFF or Ogg Vorbis. Files must be free of any digital rights management playback restrictions.

Note: Windows Media™ Player version 11 or above incorporates built in UPnP™ support. A variety of third party UPnP™ applications are available that are compatible with both Windows and OS X operating systems.

Note: More information on UPnP™ servers and networks can be found in the Naim knowledge base via: www.naimaudio.com/customer-support

4.3.5 Multiroom streams

Multiroom enables Mu-so to play audio from, and broadcast audio to, Naim streamer products connected to the same local network.

Note: In addition to Mu-so, Naim multiroom streamer products include the, NDX, ND5 XS, NAC-N 272, NAC-N 172 XS, SuperUniti, NaimUniti, UnitiQute and UnitiLite.

The Mu-so multiroom input is selected automatically when in receipt of a stream initiated from a remote Naim streamer. Mu-so can be disconnected from a multiroom stream by pressing either its touch panel or Naim App pause buttons, or by selecting an alternative input.

Note: The Mu-so multiroom input can be disabled via the Naim App Settings menu. Disabling the Multiroom input can be useful to prevent other users in a household inadvertently playing audio through it.

To broadcast Mu-so audio to a remote Naim streamer, select the Naim App Now Playing screen and touch the multiroom icon () alongside the volume slider. Touching the multiroom icon will open a dialogue window that enables other streamers connected to the same network to be selected. Up to four remote streamers can be connected simultaneously. Remote streamer volume control is also provided if available.

Note: The Mu-so local analogue and digital inputs and its Airplay and Bluetooth streaming inputs are not available for multiroom broadcast.

5. Control

Mu-so and Mu-so Qb can be controlled from their touch panel or the Naim App. The Naim App offers a comprehensive set of control and setup facilities and we recommend that before you begin to use your Mu-so or Mu-so Qb you download and install the app on your iOS or Android device. The Naim App can be found easily in both the iTunes App Store and Google Play Store.

Mu-so is also supplied with a remote control handset that provides a basic set of control functions. The handset can be purchased as an accessory to work with Mu-so Qb.

The three control interfaces are described in the following paragraphs.

5.1 The Touch Panel and Rotary Control

The touch panel display and rotary control enable selection of inputs and control of volume. Illumination display around the rotary control also indicates startup, streaming and operational processes.

To begin, touch the display Standby icon to wake Mu-so from standby. The touch panel, illustrated in Diagrams 10 to 18, incorporates the following control features:

- Audio playback touch icons across the centre of the panel enable selection of play, pause, previous and next.

Note: Mu-so audio playback controls will only operate on USB and streaming audio sources and only once play has been initiated from the Naim App.

- Above the playback icons are icons that illuminate to indicate the identity of a currently playing stream.
- In the lower half of the touch panel, radio and input touch icons indicate and enable the selection of the iRadio and local input sockets (analogue, USB and digital).

Note: AirPlay, Bluetooth, Spotify® Connect and TIDAL streams cannot be selected from the touch panel but are selected automatically when Mu-so is in receipt of a stream. Touch panel icons indicate the selection of AirPlay, Spotify®, Bluetooth and UPnP™ streams.

Note: There is no TIDAL icon on the Mu-so touch panel.

- Around the circumference of the touch panel are eleven indicator segments that illuminate to indicate volume level, radio preset selection and local input selection.

The iRadio input is selected by touching the radio icon. Mu-so will initially play the last radio station selected. If this is one of the five Mu-so radio presets, one of the five upper circumference segments will illuminate. Subsequent touches of the radio icon will select the next iRadio preset.

Note: iRadio station browsing and preset management functions are only available using the Naim App.

When one of the Mu-so local inputs is selected by touching the input icon, one of the three upper circumference segments will illuminate to indicate selection of either the analogue input, USB input or digital input. Subsequent touches of the input icon will select the next local input.

Note: Mu-so will automatically select its analogue input when a connection plug is inserted in the socket.

Note: While the Mu-so USB input can be selected from the touch panel, audio file browsing and selection functions are only available using the Naim App.

- The metallic outer section of the touch panel rotates to adjust volume. While volume adjustment is underway the circumference indicators illuminate progressively to indicate volume level.

5. Control

Diagram 10
Touch Panel and Rotary Control

Section 5 diagrams are equally applicable to both Mu-so and Mu-so Qb.

Note: Mu-so touch panel icons become selectively touch-active and illuminate depending on the input selected or playing. The touch panel in Diagram 10 shows all icons illuminated simultaneously for explanatory purposes only.

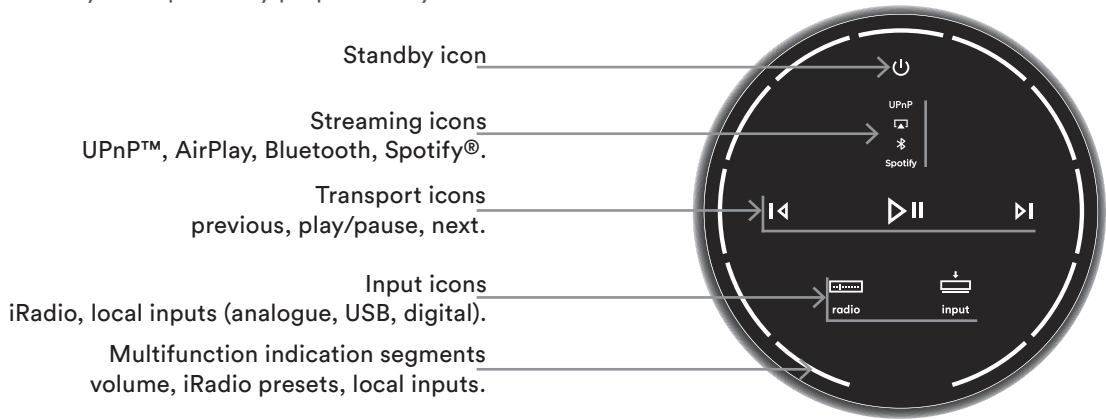

Diagram 11
Touch Standby to switch on and off
Turn the rotary control to adjust volume

Note: Touch and hold Standby to switch Mu-so to deep sleep mode. Touch Standby again to awake.

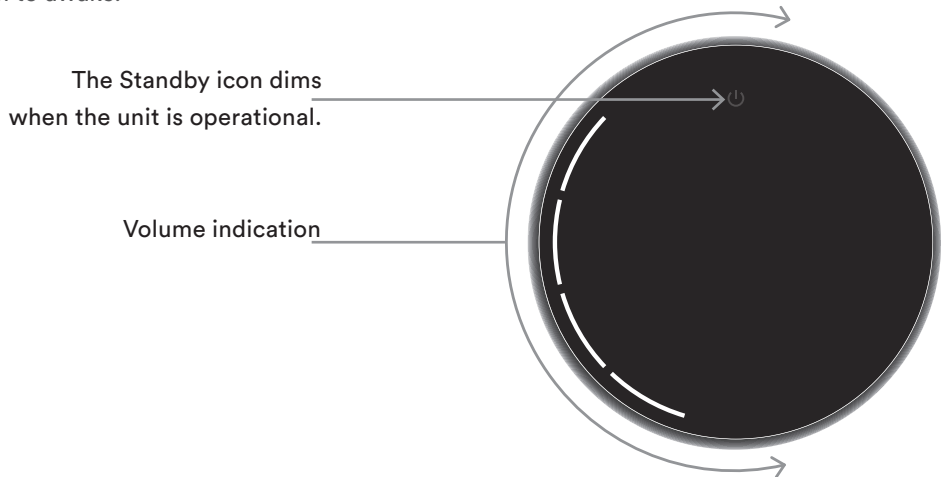
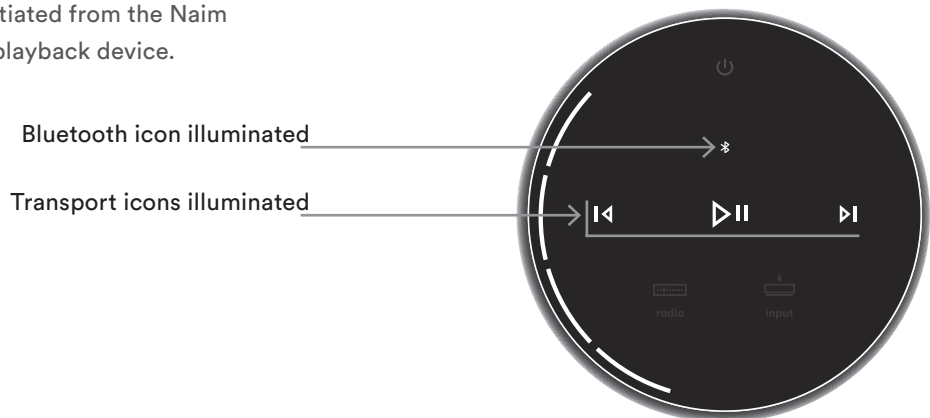

Diagram 12
Bluetooth stream playing

Note: Transport icons are only illuminated and touch-active once playback has been initiated from the Naim App or directly from a Bluetooth playback device.



5. Control

Diagram 13
UPnP™ stream playing

Note: Transport icons are only illuminated and touch-active once playback has been initiated from the Naim App or directly from a UPnP™ playback device.

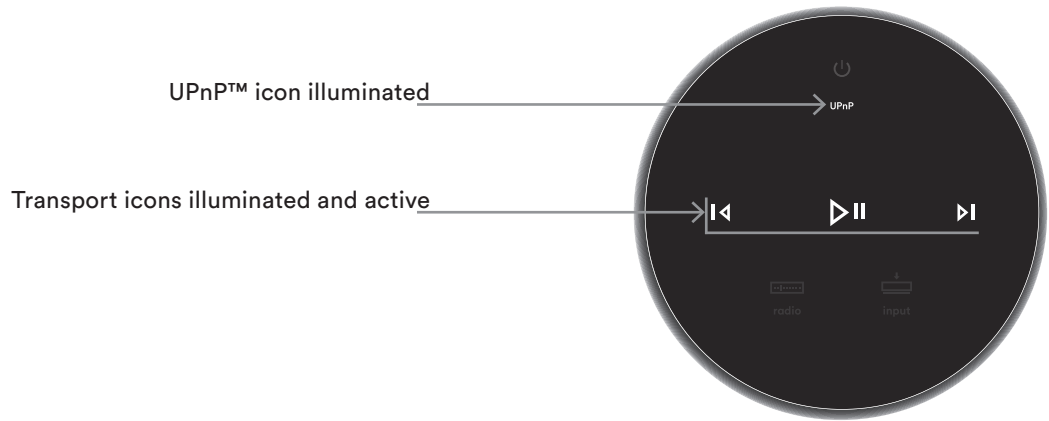

Diagram 14
AirPlay stream playing

Note: Transport icons are only illuminated and touch-active once playback has been initiated from the Naim App or directly from an AirPlay playback device.

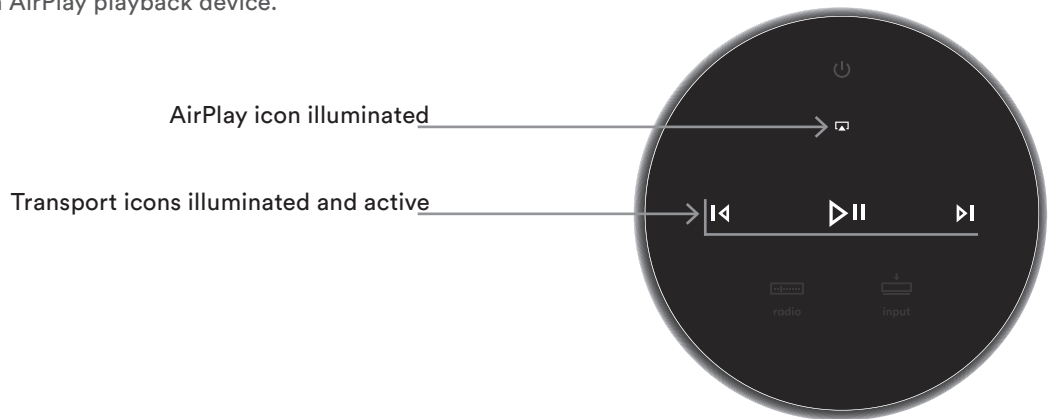
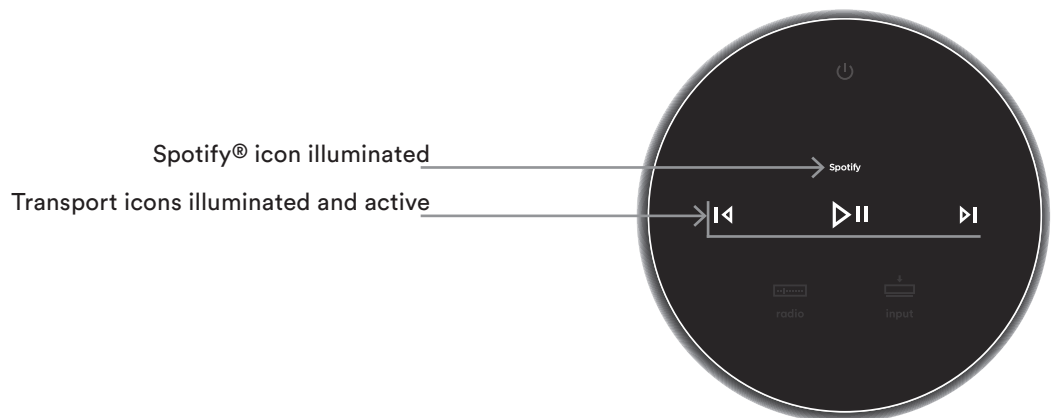

Diagram 15
Spotify® Connect stream playing

Note: Transport icons are only illuminated and touch-active once playback has been initiated from the Naim App or directly from a Spotify® Connect playback device.



5. Control

Diagram 16
TIDAL stream playing

Note: There is no TIDAL icon on the Mu-so touch panel.
Transport icons are only illuminated and touch-active once playback has been initiated from the Naim App.

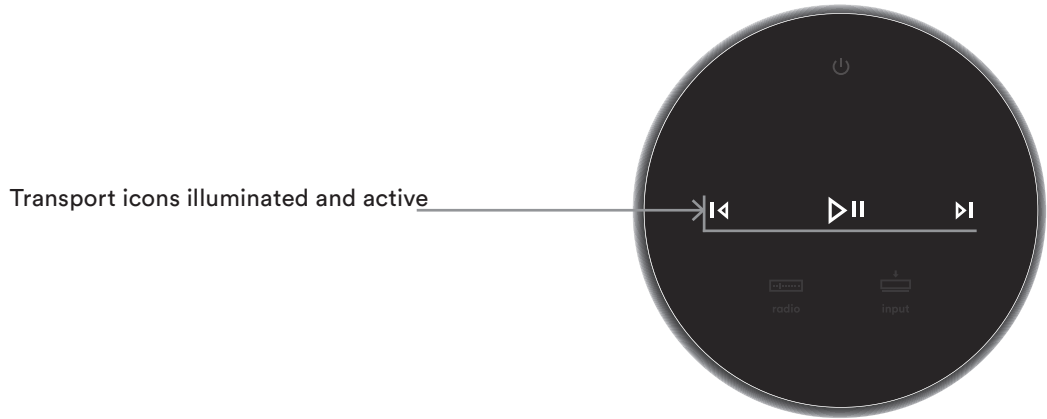

Diagram 17
iRadio input

Note: Touch the radio icon to select presets sequentially.

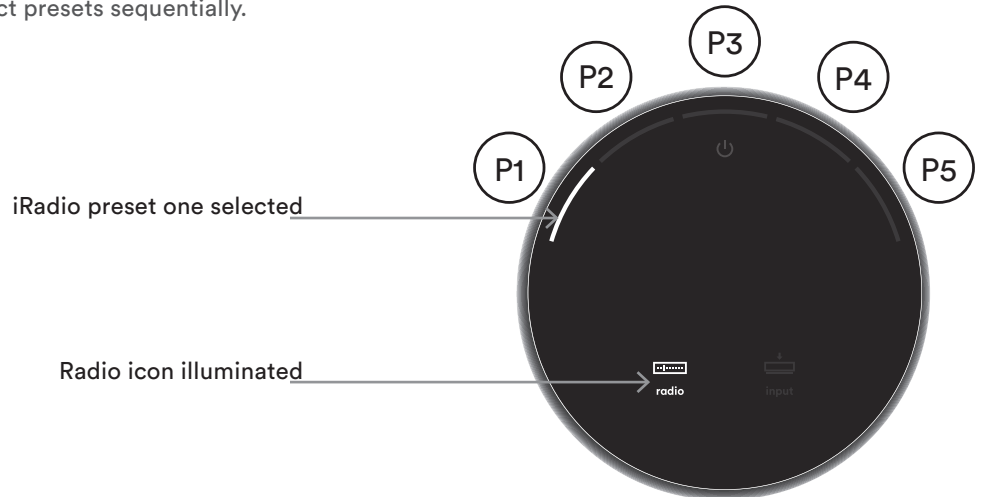
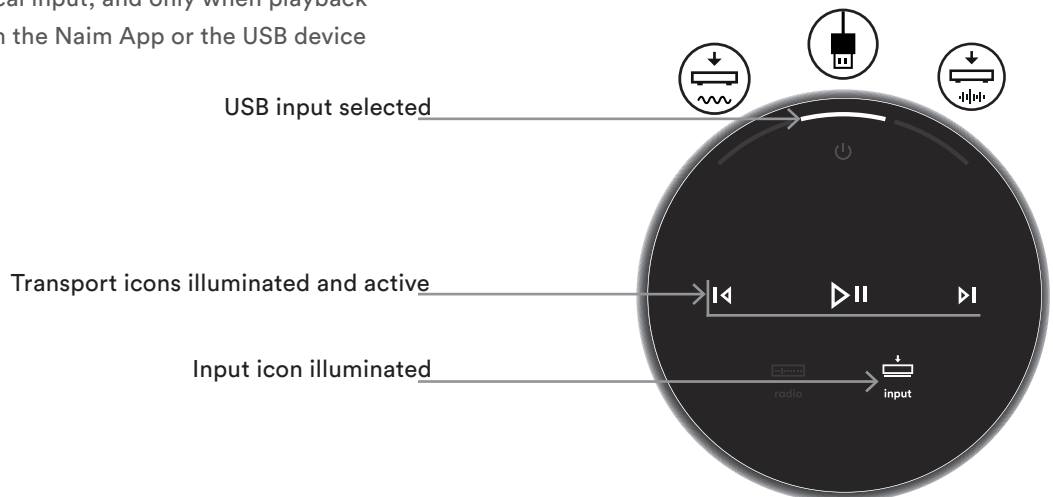

Diagram 18
Local inputs

Note: Transport icons are only illuminated and touch-active with the USB local input, and only when playback has been initiated from the Naim App or the USB device itself.



5. Control

5.2 The Mu-so Remote Control Handset

Note: Mu-so Qb is not supplied with a remote control handset but is enabled for remote control. Mu-so remote control handsets are available for purchase as an accessory or replacement from: www.naimaudio.com

Mu-so is supplied with a remote control handset that provides access to basic control functions. The handset battery is ready-fitted, however an insulating tab must be removed before the handset can be used. Remove the battery cover and pull the transparent tab away from the battery.

Unreliable operation of the remote handset is most likely due to an exhausted battery. Replacement batteries of the CR2032 type required are widely available. Take care to fit the replacement battery with the correct polarity.

The remote control handset is illustrated and its button functions annotated in Diagram 19.

Diagram 19
Mu-so remote handset

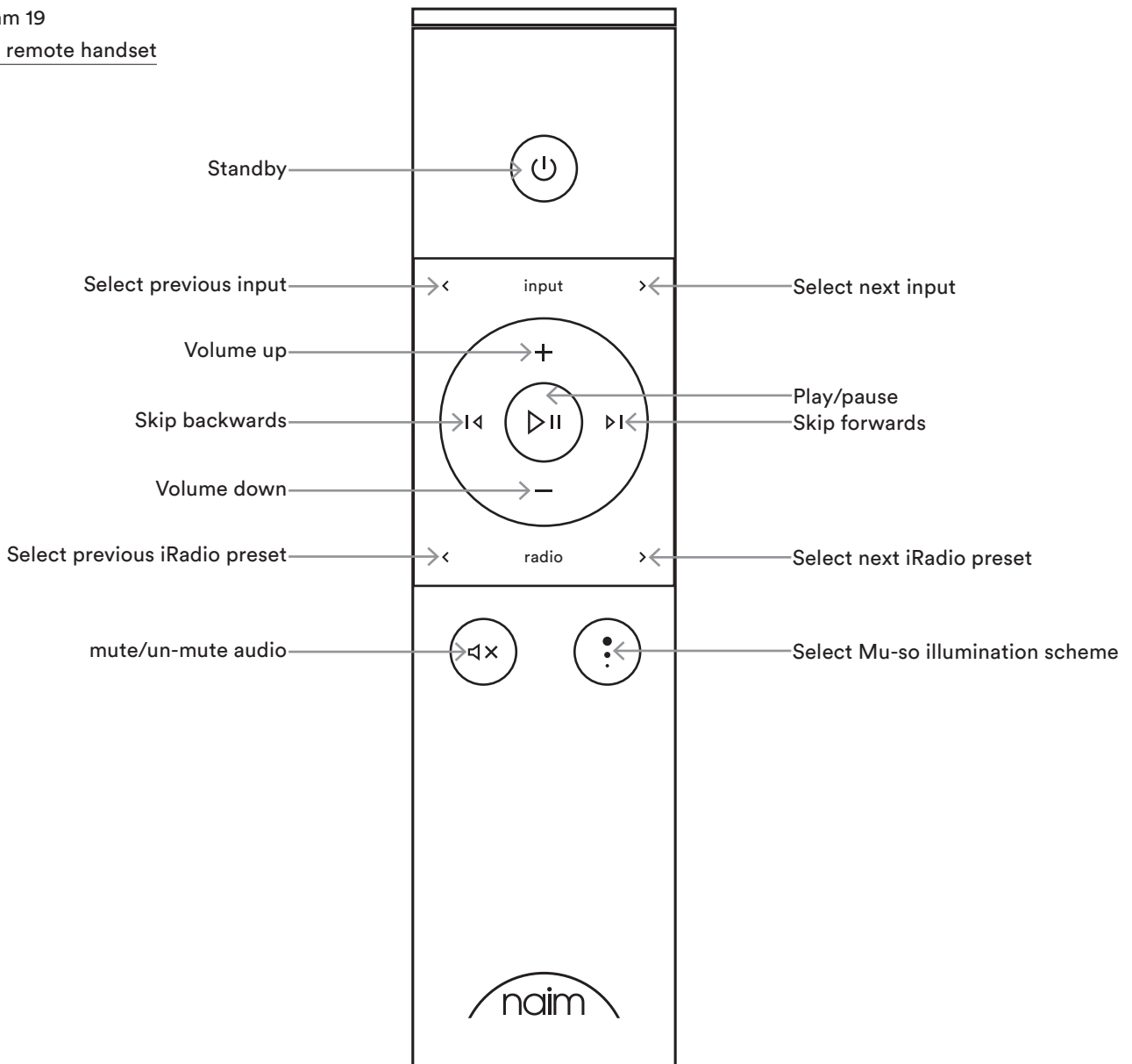

5. Control

5.3 The Naim App

The Naim App behaves identically with Mu-so and Mu-so Qb.

The Naim App comprises pages dedicated to each of the Mu-so streaming sources and inputs and pages dedicated to Mu-so setup. The Naim App is intuitive in use and its capabilities and philosophies are best learned by using it to configure Mu-so to suit your needs. To begin using the Naim App follow the steps below:

- Download and install the Naim App on your iOS or Android device.
- Ensure that the device is connected to the same network as the Mu-so and open the Naim App.
- From the Settings menu select Mu-so to connect the app. Diagram 20 illustrates selection of Mu-so from the Naim App setup page.

Note: If you have multiple Naim streaming products connected to your network they will be listed for selection in the Naim App setup page. The correct unit can be identified either by its product name or, in the case of multiple identical products, by the first four characters of each units' unique MAC addresses appended to its product name. The individual Mu-so MAC address can be found on the serial number label affixed to its underside.

Diagram 20
Naim App Setup

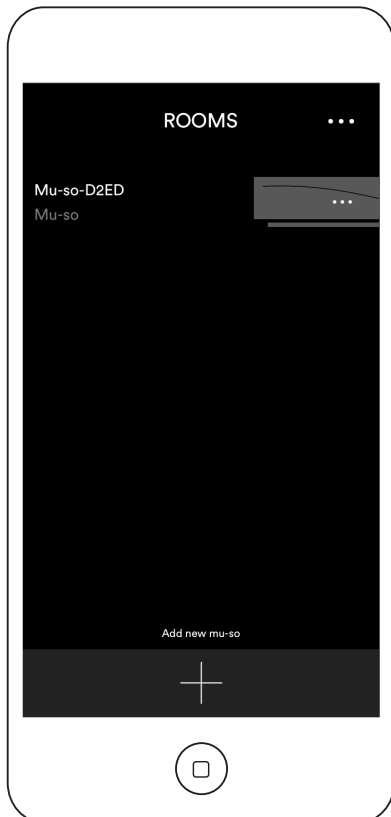

Note: The Naim App Settings menu enables Mu-so and Naim streaming product default names to be changed. Designating each Mu-so or streamer with a name that reflects their location will help make multiroom control more satisfying and intuitive. See Section 5.3.2.

5.3.1 Selecting Inputs from the Naim App

With your Mu-so selected, the Naim App Input icons will configure to reflect the inputs available. Select the required input. Diagram 21 illustrates the Naim App home page and Input icons.

Diagram 21
Naim App Home

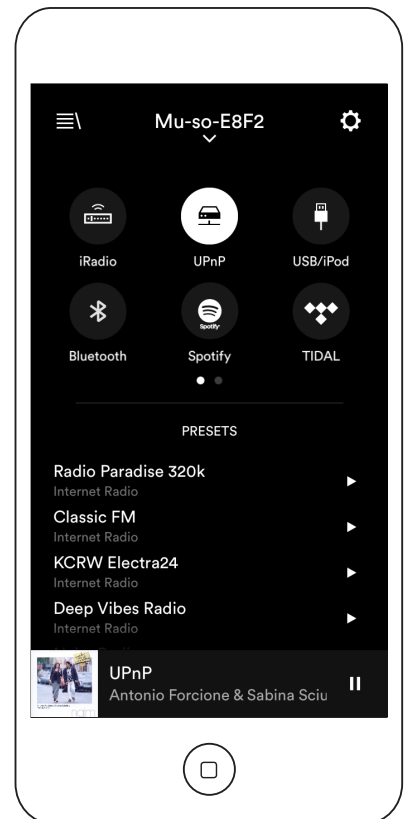

If a streaming source such as AirPlay or Spotify® is selected automatically on Mu-so by the presence of a stream, the Naim App display will switch to the appropriate streaming source page and offer the controls available to that stream type. If an alternative source is selected using the Naim App the stream playback will stop and Mu-so will disconnect from the stream source.

Note: Only one instance of the Naim App can be connected to a single Mu-so at any time.

5. Control

5.3.2 Setup using the Naim App

The Naim App provides comprehensive access to all Mu-so and Mu-so Qb setup parameters. All the setup parameters and functions are listed in the following paragraphs. Diagram 22 illustrates the Naim App Settings page.

The Settings menu provides ten items: Standby, Loudness, Alarm clock, Lighting, Styles, Input settings, Room position, Other settings, Register your product and About.

Standby

Switches Mu-so into standby mode.

Loudness

Loudness applies a bass boost that decreases as volume is increased. By compensating for the ear's reduced bass sensitivity at low volume levels, loudness compensation can make low volume listening more satisfying.

Alarm Clock

Enables a Mu-so Alarm Clock function to be programmed.

Note: Mu-so can only use audio from its local inputs (Analogue or Digital) or its iRadio presets as alarm signals. If an alarm is critical you must be certain that a suitable alarm signal will be playing at the programmed alarm time.

Diagram 22
Naim App
Settings

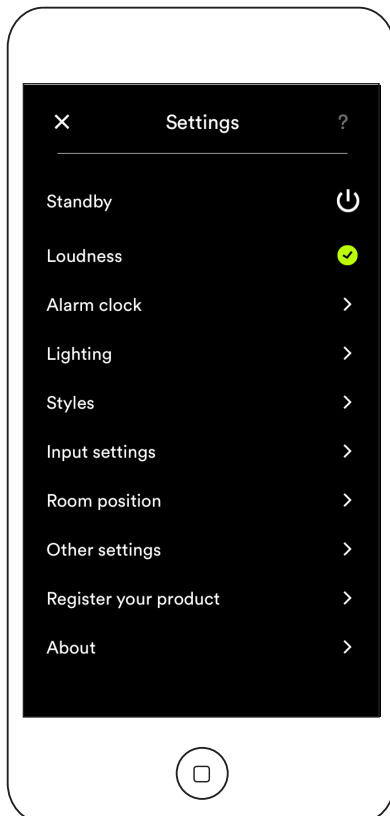

Lighting

Lighting provides four illumination schemes offering options of brightness and activity.

Styles

Styles enables various Naim App background colour options to be selected.

Input settings

Input settings item provides a variety of options tailored to each type of input.

Room position

Room position enables adjustment of Mu-so tonal balance to compensate for the proximity of walls and other large surfaces. If Mu-so is placed on a shelf, for example, tonal adjustment can be useful in reducing the bass boost that naturally results from such a location.

Other settings

The Other settings menu provides access to a variety of app interface and configuration options.

Register your product

Opens the Mu-so product registration page of the Naim website.

About

The About menu provide third party licence information and information on Mu-so firmware and connection status.

6. Installation Notes

6.1 Handling Mu-so

Take great care when lifting, carrying and inverting Mu-so to access the mains power, network and digital audio sockets.

Do not invert your Mu-so or Mu-so Qb so that weight is borne by its top surface or touch panel. Damage to the touch panel or top surface finish may result. Do not stand Mu-so or Mu-so Qb on either end panel or grilles.

6.2 Cleaning Mu-so

Your Mu-so should not need cleaning beyond dusting. Do not use wax or solvent based cleaning products. If necessary, a damp cloth may be used on the external casework, however it is important that all liquids are kept away from the touch panel and rotary control.

6.3 Grille Replacement

The standard Mu-so and Mu-so Qb black grilles can be replaced with a range of coloured grilles available through your local Naim retailer or at: www.naimaudio.com/mu-so.

- To remove the Mu-so grille grasp both ends of the grille simultaneously and gently pull the grille away from the Mu-so body.

To fit a Mu-so grille, line-up the grille studs with the fixing holes and gently push the grille home. Ensure that the grille is in the correct orientation. The grille curve runs from top left to bottom right.

- To remove the Mu-so Qb grille first gently peel the top rear corner of one side grille away from the Mu-so Qb body. Once the rear edge of one side grille is released, repeat with the other side. With both sides released the grille can be gently pulled away from the front.

To fit a Mu-so Qb grille first line-up the front grille studs and fixing holes and gently push the front section of the grille home. Next similarly fit the forward half of one side grille followed by its rear edge. Repeat with the other side grille.

Note: Do not touch any of the drive-units while the grilles are removed.

6.4 Firmware Update

Updated Mu-so and Mu-so Qb firmware may be released from time to time. Updated firmware may introduce new features or modify existing behaviour or performance. The Naim App incorporates a firmware update routine in its Settings menu.

Important: Never switch off your Mu-so or Mu-so Qb or disconnect it from the mains supply or network while a firmware update procedure is underway.

Note: The Naim App firmware update routine can also be used to check that the currently installed firmware is up to date.

Note: The Mu-so setup web page also includes a firmware update link. This should be used only on the advice of Naim support staff.

6.5 Lightning Precautions

Mu-so and Mu-so Qb can be damaged by lightning and should be turned off and disconnected from the mains and any wired connection when there is risk of lightning.

6.6 Defaults

To return your Mu-so or Mu-so Qb to its default settings use the pin-tool supplied (or a straightened paperclip) to press and hold the pin-hole button adjacent to the status indicator (see Diagrams 2 and 3 respectively for Mu-so and Mu-so Qb). Hold the button pressed for six seconds. Mu-so or Mu-so Qb will return to its default settings and restart. The rotary control and logo illumination will flash while the factory default procedure is underway.

6.7 Problems?

Consumer protection varies from country to country. In most territories a retailer must be prepared to take back any equipment sold if it cannot be made to work satisfactorily. A problem may be due to a fault in the product or its installation. Please contact your local distributor, or Naim Audio directly, if any difficulties cannot be resolved. Contact Naim Audio directly for help and advice if necessary.

6.8 Service and Contact

It is essential that repairs are only carried out by an authorised Naim retailer or at the Naim Audio factory. Direct contact to Naim for service or update information should be made initially through Customer Services: info@naimaudio.com

For help with Mu-so or Mu-so Qb installation and operation please visit: www.naimaudio.com/mu-so-support

For email support contact:
mu-sosupport@naimaudio.com

For telephone support call:
+44 (0)333 321 9923 (UK)
+1 800 961 5681 (USA and Canada)

Please quote the product serial number (found on its underside panel) in all correspondence.

7. Specifications

Audio Inputs:	AirPlay, Spotify® Connect, TIDAL, Internet Radio, UPnP,™ and Naim Multiroom via Ethernet or Wi-Fi Bluetooth (with aptX) USB/iOS (USB Type-A socket) Digital: Optical S/PDIF (TosLink) up to 96kHz Analogue: 3.5mm jack	Internet radio:	vTuner premium
Audio formats:	WAV, FLAC and AIFF up to 24bit/192kHz ALAC (Apple Lossless) up to 24bit/96kHz MP3 up to 48kHz, 320kbit (16 bit) AAC up to 48kHz, 320kbit (16bit) OGG and WMA up to 48kHz (16bit) Bluetooth SBC, AAC and aptX	Connectivity:	Ethernet (10/100Mbps) Wi-Fi (802.11b/g) Bluetooth RC5 remote-control
		Speaker system:	Mu-so: Dual three-way. Reflex loading. Mu-so Qb: Dual two-way with mono subwoofer. Dual ABR loading.
		Amplification:	Mu-so: 6 × 75 Watts into 6 Ohms Mu-so Qb: 4 × 50 Watts into 6 Ohms 1 × 100 Watts into 3 Ohms
		Dimensions:	Mu-so: 122mm (4.8”) x 628mm (24.7”) x 256mm (10.1”) Mu-so Qb: 210mm (8.25”) x 218mm (8.60”) x 122mm (8.35”)
		Weight:	Mu-so: 13.0kg (28.7lb) Mu-so Qb: 5.6kg (12.3lb)
		Finish:	Brushed aluminium casework, silver anodised heatsink, black fabric grille. Grille options in Deep Blue, Vibrant Red, Burnt Orange.
		Power consumption:	Mu-so: Typical use: 17W, Standby mode: < 4W, Deep sleep: < 0.5W Mu-so Qb: Typical use: 15W, Standby mode: < 4W, Deep sleep: < 0.5W
		Mains supply:	100V, 115V or 230V, 50/60Hz

Note: All formats to 48kHz maximum over wireless network.

CE Declaration of Conformity

Naim Audio declares that Naim Audio products are in conformance with:
Low Voltage Directive 2014/35/EU
Electromagnetic Compatibility Directive 2014/30/EU
Restriction of Hazardous Substances (RoHS2) Directive 2011/65/EU
Waste of Electrical and Electronic Equipment Directive 2012/19/EU
Energy related Product Directive 2009/125/EC
Radio & Telecommunications Terminal Equipment (R&TTE) Directive 1999/5/EC

Naim Audio Ltd. declares that Mu-so is in compliance with the essential requirements and relevant provisions of Directive 1999/5/EC.

Naim Audio products comply with the following standards:
EN60065 - Audio, video and similar electronic apparatus - Safety requirements
EN55013 - Sound and television broadcast receivers and associated equipment - Radio disturbance characteristics
EN55020 - Sound and television broadcast receivers and associated equipment - Immunity characteristics
EN61000-3-2 - Mains harmonics current emissions
EN61000-3-3 - Mains flicker emissions

Products that display the crossed-out wheeled bin logo cannot be disposed of as domestic waste. These products must be disposed of at facilities capable of re-cycling them and appropriately handling any waste by-products. Contact your local authority for details of the nearest such facility. Appropriate recycling and waste disposal helps conserve resources and protects the environment from contamination. Naim Audio offers a 'take back' scheme as part of its commitment to the Waste of Electrical and Electronic Equipment Directive 2012/19/EU. Customers wishing to return products for disposal may do so by sending them to the address below. Products returned for disposal must be clearly and unambiguously marked, "For disposal under WEEE Directive".



8. Acknowledgements



mu-so® is a registered trademark of Naim Audio Ltd. Registered in the United Kingdom and other countries.



Mu-so works with iPhone 5s, iPhone 5c, iPhone 5, iPhone 4s and iPhone 4, iPad mini and iPod touch (5th generation).

Mu-so Qb works with iPhone 6 Plus, iPhone 6, iPhone 5s, iPhone 5c, iPhone 5, iPhone 4s, iPad Air 2, iPad Air, iPad mini 3, iPad mini 2, iPod touch (5th generation) and iPod nano (7th generation).



AirPlay

AirPlay works with iPhone, iPad, and iPod touch with iOS 4.3.3 or later, Mac with OS X Mountain Lion, and Mac and PC with iTunes 10.2.2 or later.

AirPlay, iPad, iPhone and iPod are trademarks of Apple Inc., registered in the U.S. and other countries.



This product incorporates Spotify® software which is subject to 3rd party licences found here:
www.spotify.com/connect/third-party-licenses



HIGH FIDELITY MUSIC STREAMING



The Bluetooth® word mark and logos are registered trademarks owned by Bluetooth SIG, Inc. and any use of such marks by Naim Audio Ltd. is under licence. Other trademarks and trade names are those of their respective owners.



© 2012 CSR plc and its group companies.

The aptX® mark and the aptX logo are trade marks of CSR plc or one of its group companies and may be registered in one or more jurisdictions.



Wi-Fi® logo is a registered trademark of Wi-Fi Alliance.



UPnP™ is a trademark of the UPnP™ Forum.

Go Deeper



naimaudio.com

Naim Audio Ltd., Southampton Road, Salisbury, England SP1 2LN

T: +44 (0)333 321 9923 (UK), +1 800 961 5681 (USA and Canada) E: mu-sosupport@naimaudio.com W: www.naimaudio.com